



xangati

UKNOF17

The opportunity



VMWare deployments the “way to go” in many organisations and for very good reason:

- more efficient use of hardware

- cost savings – power, rack space, cost of adding more process, speed of adding more process

Moving from Physical to Virtual - P2V

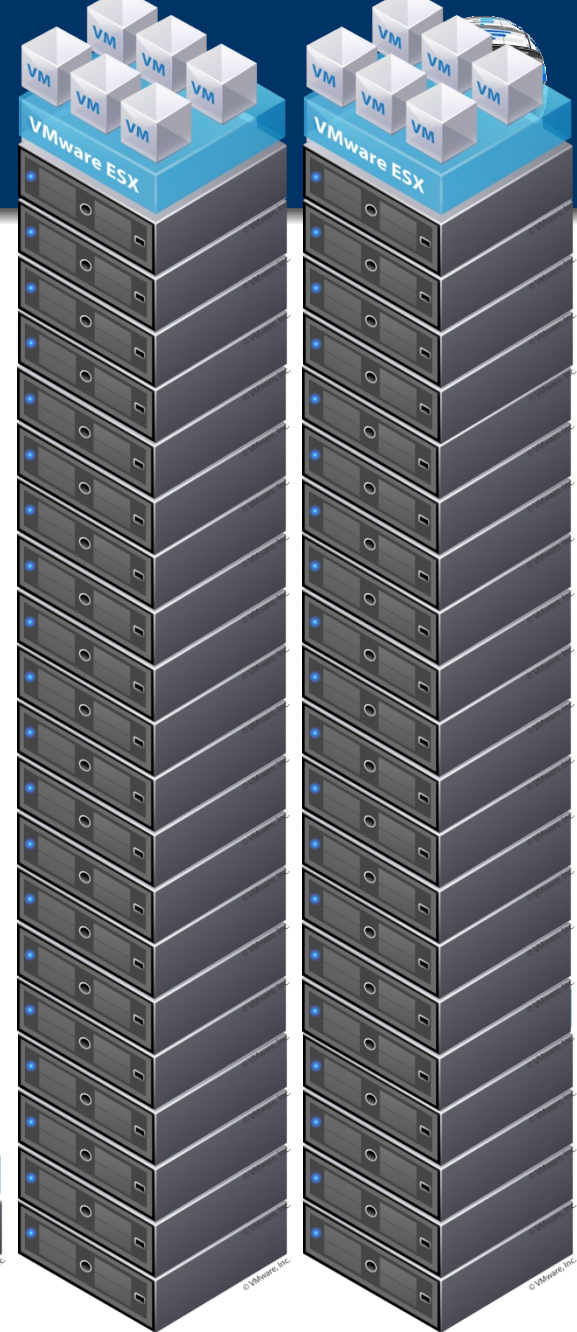
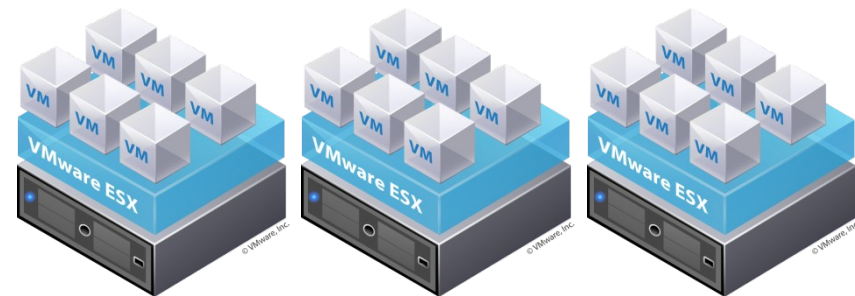
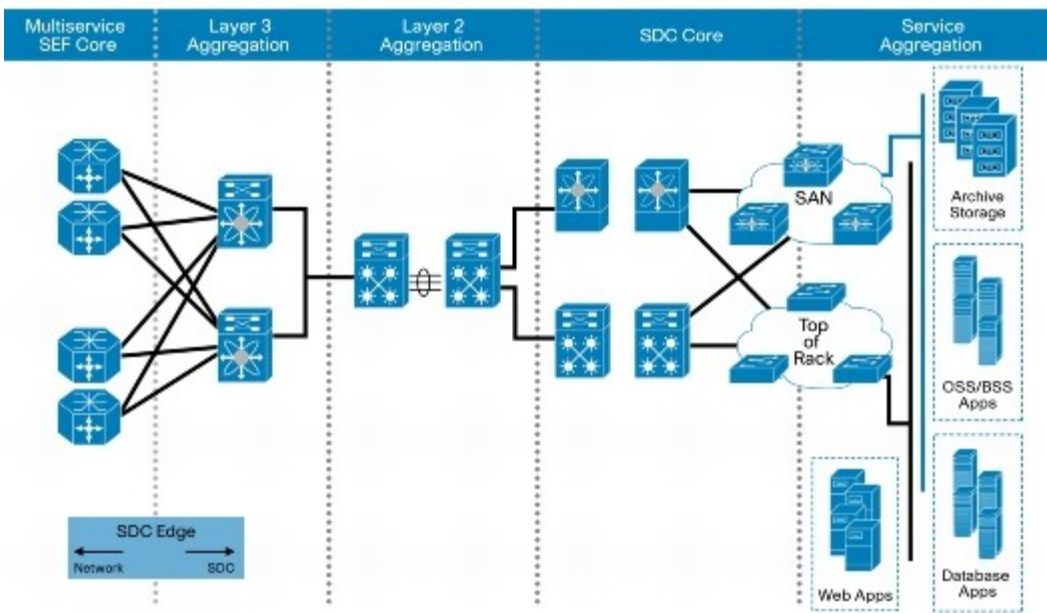

The issue



Network Administrators lose visibility of activity between VM hosts in the virtual world

Silo Approaches Breed Conflict



Network Team:
“everything is ok – virtualization
must be the problem”

Virtualization Team:
“I can’t prove it – but it surely
can’t be virtualization ...”

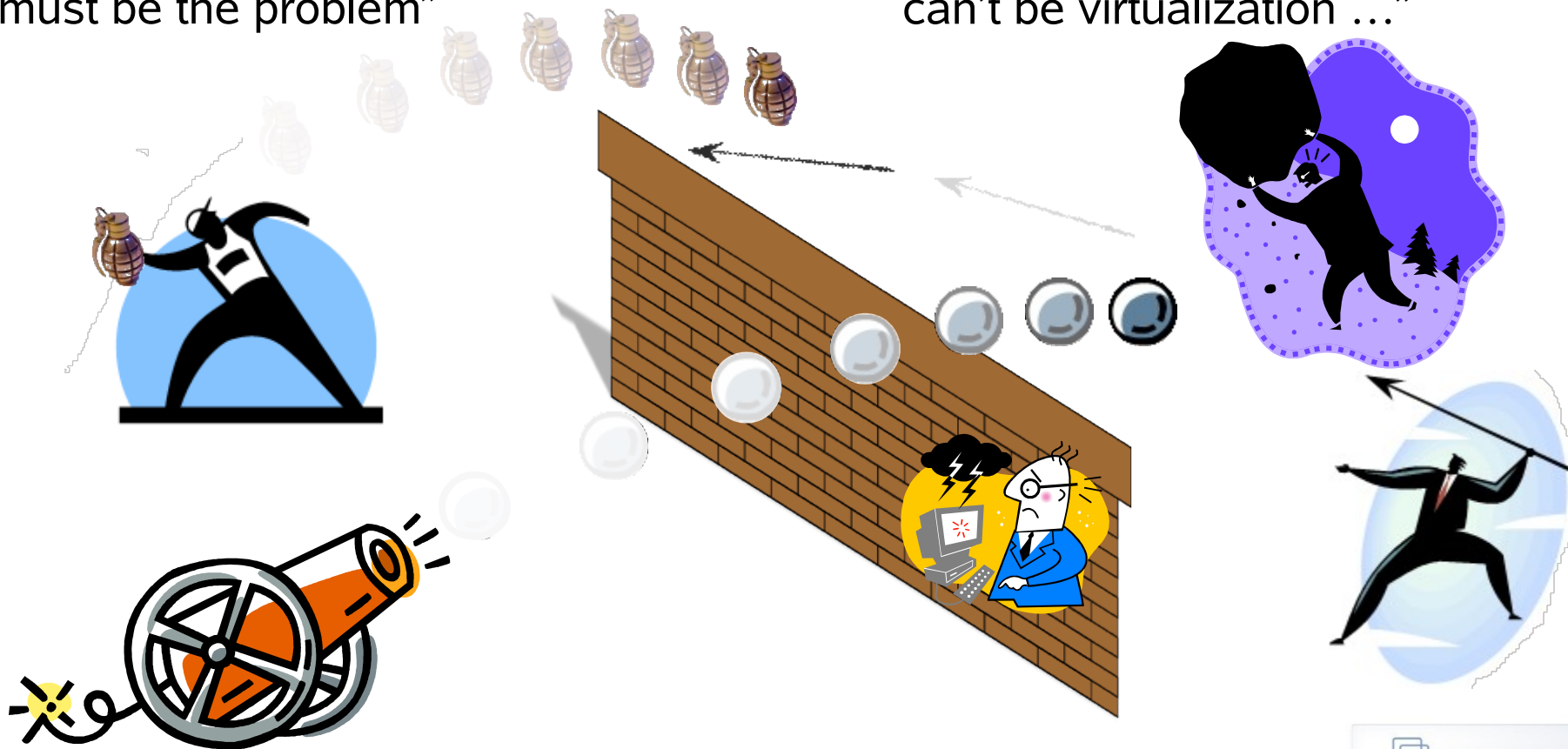

VMWare's limited view

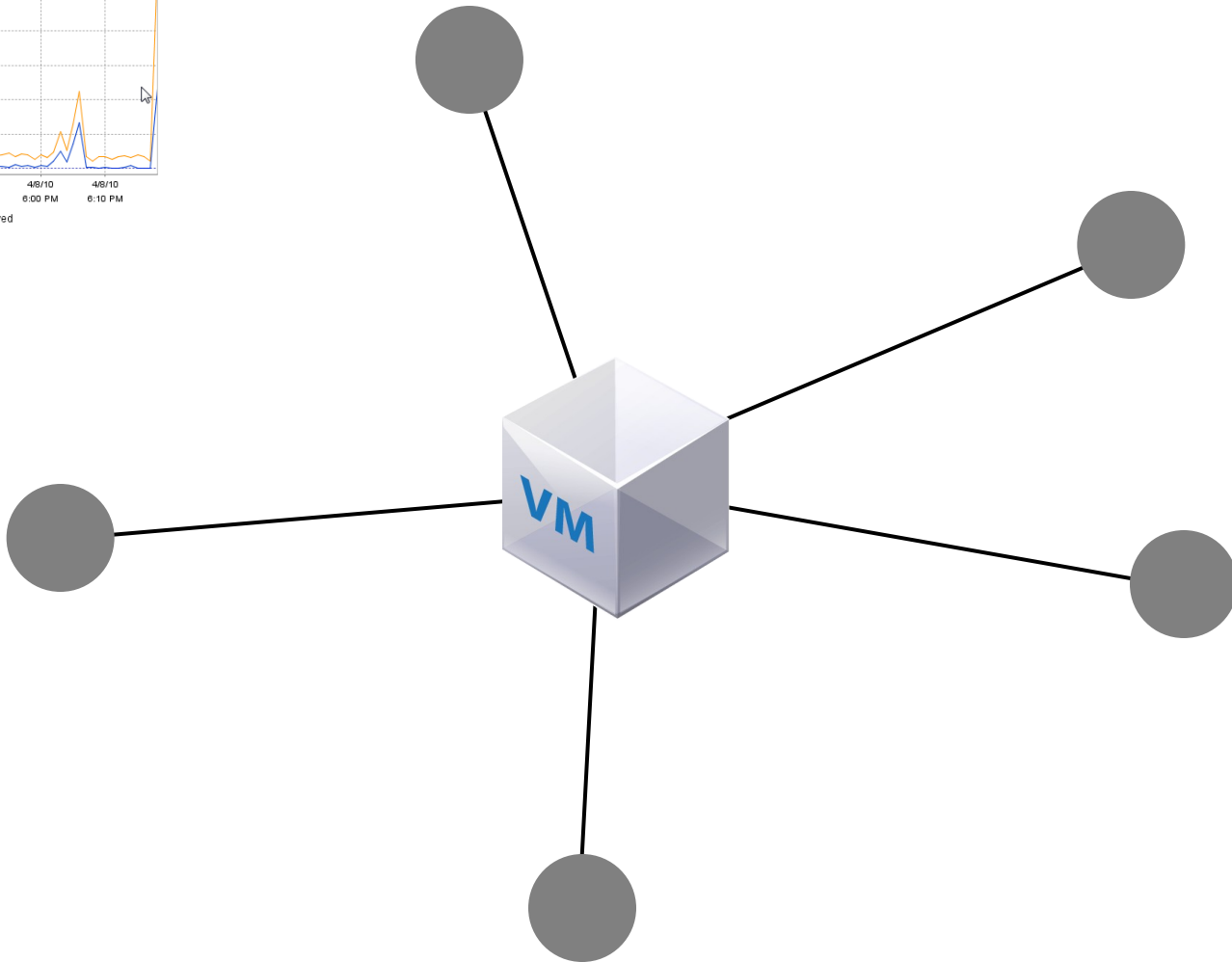
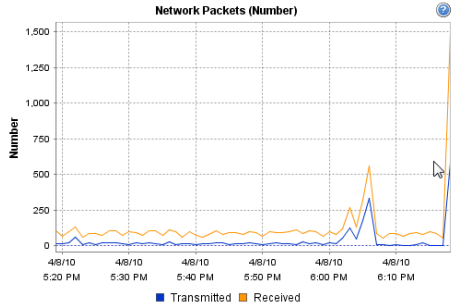

Ultralight Deployment



SINGLE DASHBOARD



MULTIPLE DASHBOARDS

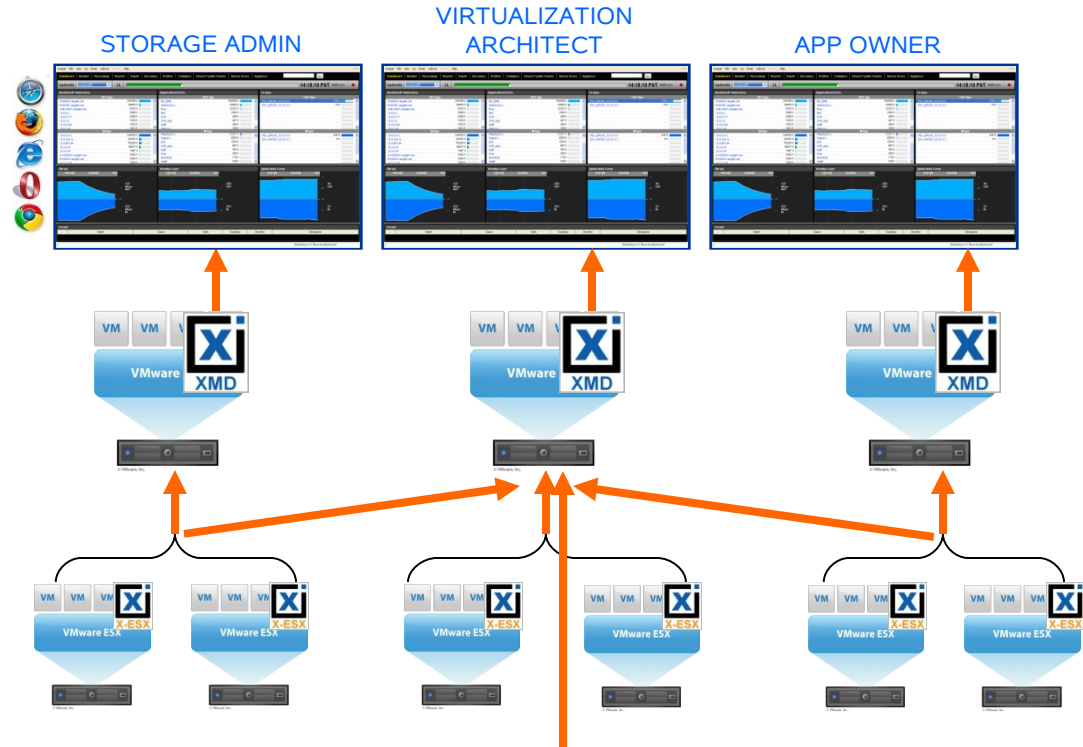

Xangati Virtual Appliances

	XANGATI FOR ESX
	XANGATI MANAGEMENT DASHBOARD



Xangati Shows Detailed VM-to-end Communications

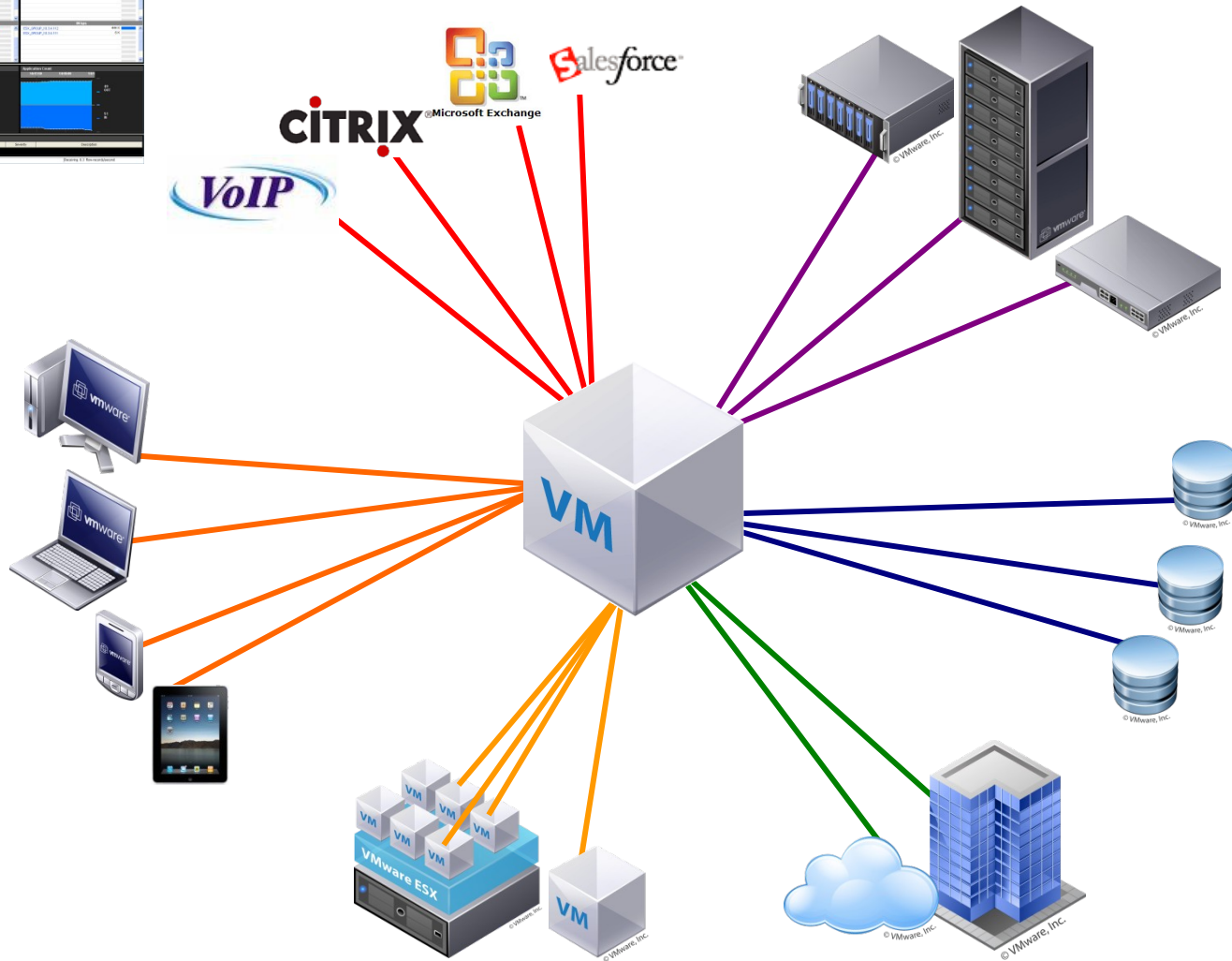

Xangati Delivers Unrivaled VM Insight



- Live, to-the-second visibility
- Auto-discovery
- Auto-naming
- Auto-recording
- Alerting
- Custom dashboards

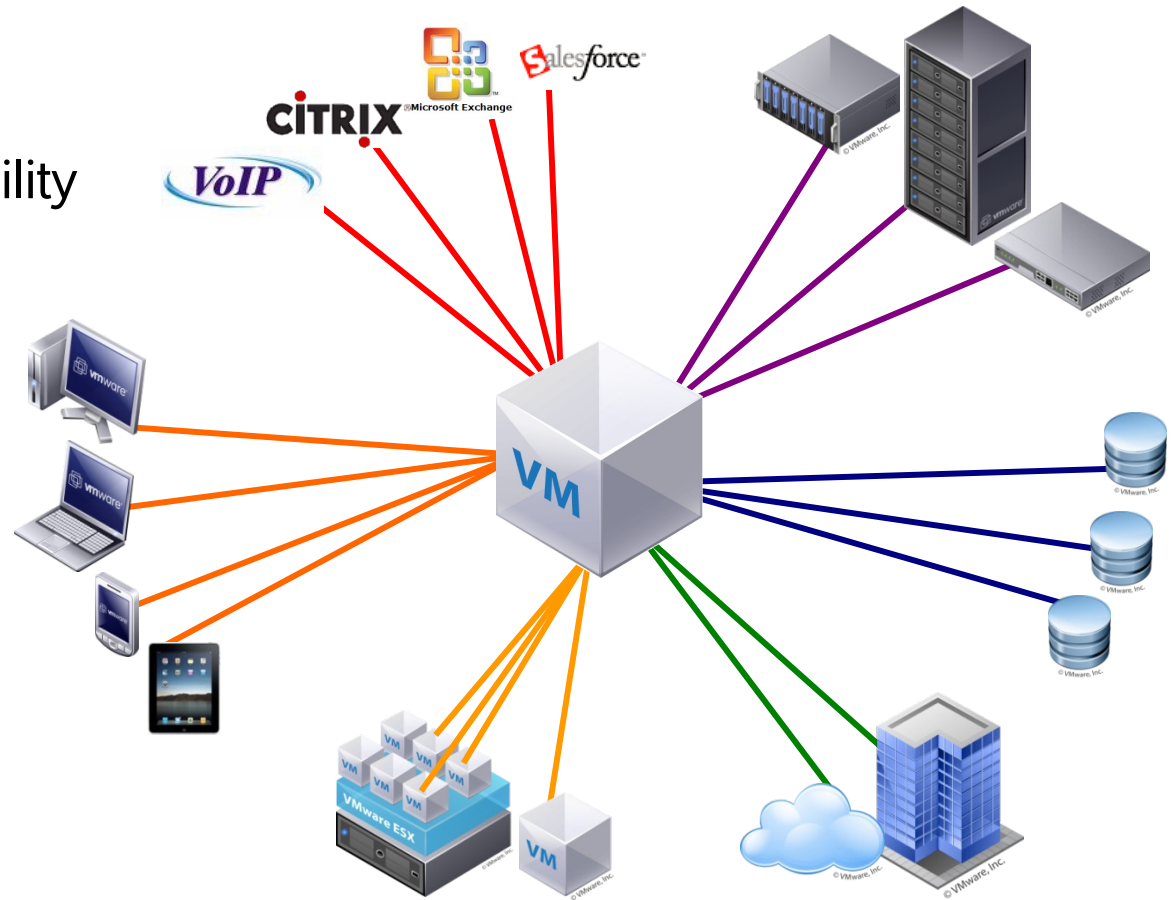

Full Internal Visibility

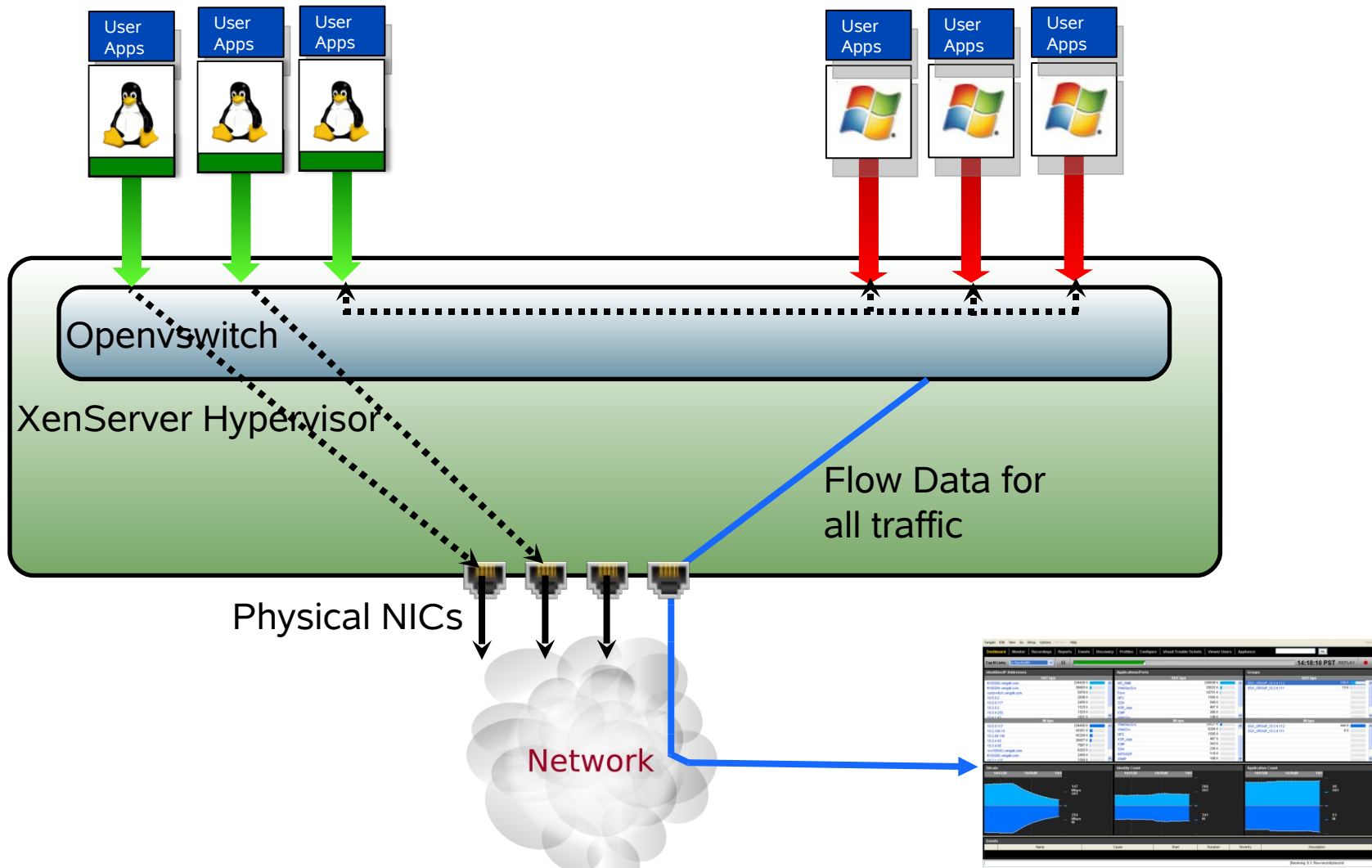

About Xangati



- Over 100+ customers worldwide
 - Proven technology
 - Cost Effective
 - Scales from 1,000 users to over 250,000+
- Headquartered in Cupertino, CA
 - Development in Cupertino & Pune, India
- Proprietary Technology
 - 10 patents pending, 3 issued



GARTNER COOL VENDOR,
2009



STARTUP TO
WATCH IN 2009



2009 INFORMATION
WEEK
STARTUP 50



IT MANAGEMENT
SOFTWARE COMPANY
TO WATCH IN 2008



TOP TECH
STARTUP, 2008



2007 TECH STARTUP
THAT MATTERS



ABA FINALIST:
2009 NEW PRODUCT OF
THE YEAR — TELECOM



xangati

Demo

